

# INTÉGRATION DU PRÉAMPLI 4 BANDES

TOUJOURS ACTIF

A

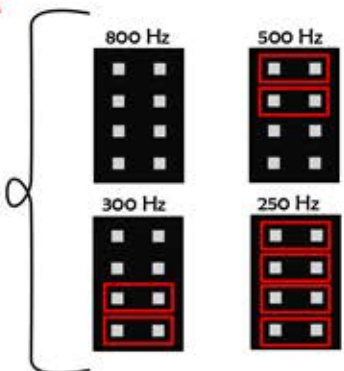

Selection des fréquences bas médium

B

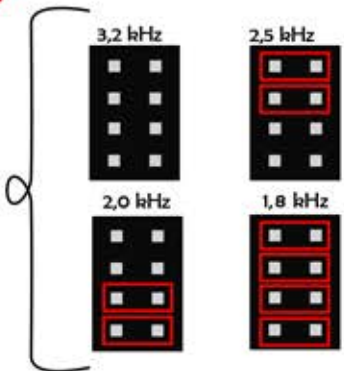

Selection des fréquences haut médium

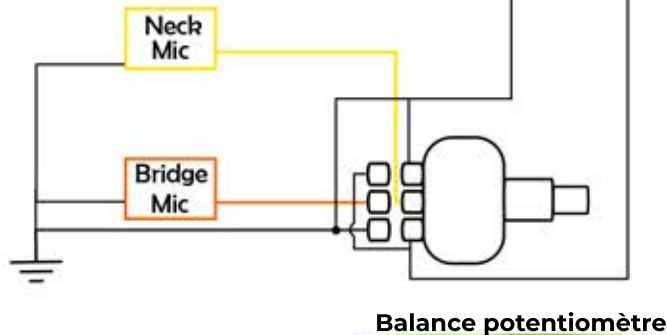
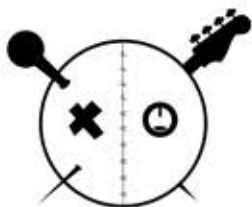

Balance potentiomètre

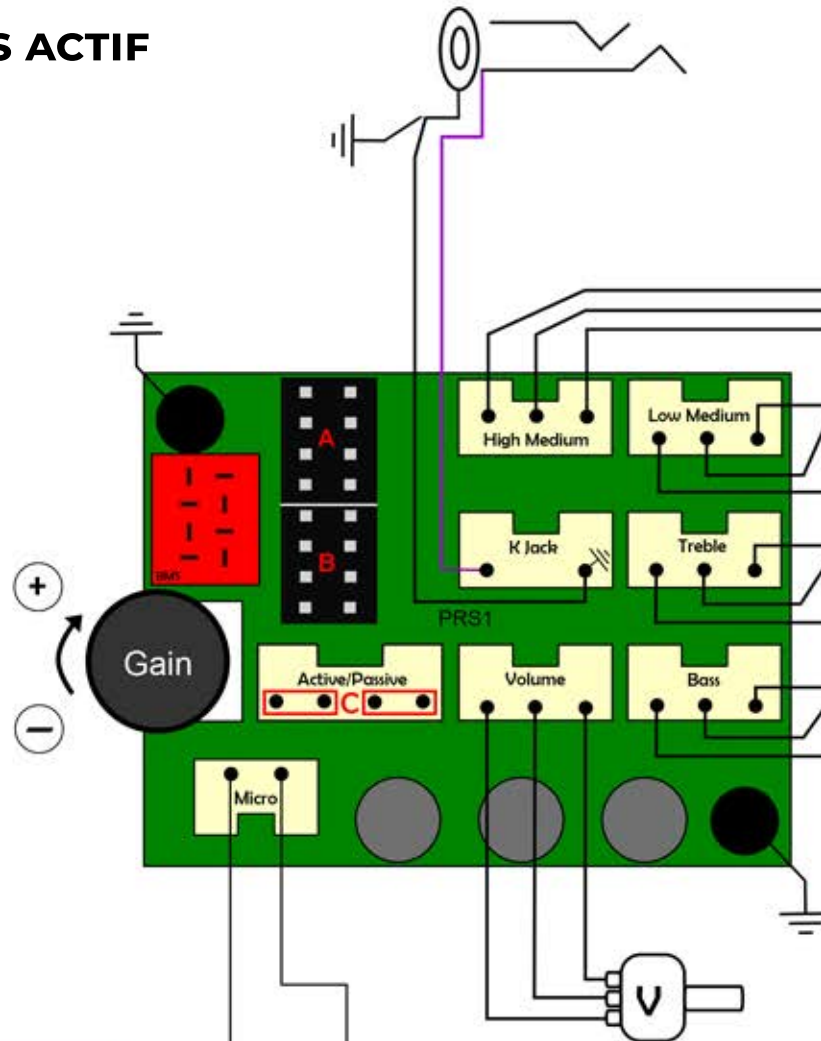

OBSERVATION : POTENTIOMÈTRE VU DE DESSOUS

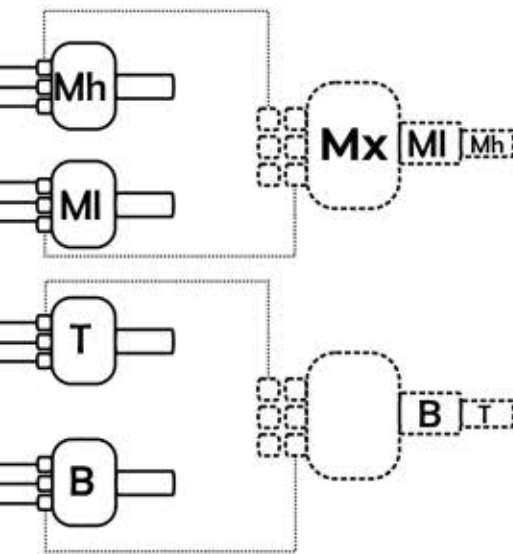

PRÉAMPLI AVEC PILE 9V

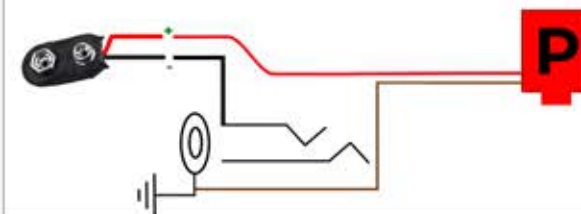

2X PILE 9V

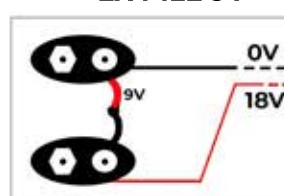

CONNEXION À UN PRÉAMPLI VAUDDO AUDIO

